

Proportional Relief Valves

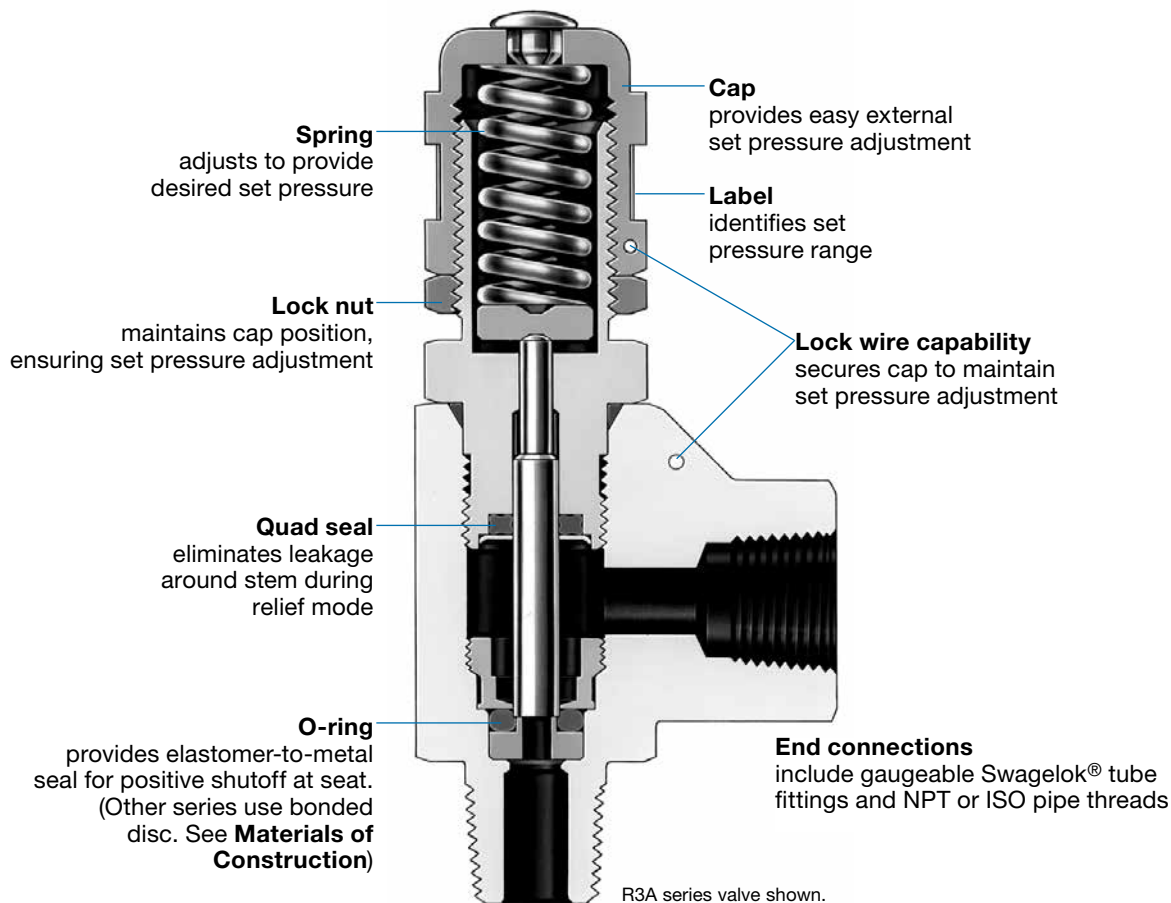

R Series

- Liquid or gas service
- Set pressures from 10 to 6000 psig (0.7 to 413 bar)
- 1/4 and 1/2 in. and 6 to 12 mm end connections



Features

High-Pressure Valves

- Service up to 6000 psig (413 bar)
- Multiple springs for a selection of set pressure ranges
- Valves available factory-set to a specified set pressure
- 1/4 in. and 6 and 8 mm end connections—R3A series
- 1/2 in. and 12 mm end connections—R4 series

Low-Pressure Valves

- Service up to 300 psig (20.6 bar)
- One spring for the full set pressure range
- Valves available factory-set to a specified set pressure
- 1/4 in. and 6 and 8 mm end connections—RL3 series
- 1/2 in. and 12 mm end connections—RL4 series

Applications

R series relief valves are proportional relief valves that open gradually as the pressure increases. Consequently, they do not have a capacity rating at a given pressure rise (accumulation), and they are not certified to ASME or any other codes.

⚠ **Some system applications require relief valves to meet specific safety codes. The system designer and user must determine when such codes apply and whether these relief valves conform to them.**

⚠ **Swagelok proportional relief valves should never be used as ASME Boiler and Pressure Vessel Code safety relief devices.**

⚠ **Swagelok proportional relief valves are not “Safety Accessories” as defined in the Pressure Equipment Directive 2014/68/EU.**

Operation

R series relief valves OPEN when system pressure reaches the set pressure and CLOSE when system pressure falls below the set pressure.

■ High-pressure R3A and R4 series—select and install the spring that covers the required set pressure; apply the matching label to the cap.

■ Low-pressure RL3 and RL4 series—the spring is already installed.

⚠ **For valves not actuated for a period of time, initial relief pressure may be higher than the set pressure.**

Technical Data

Pressure-Temperature Ratings

Series	R3A					R4				RL3 and RL4			
Inlet Working Pressure ^①	6000 psig (413 bar); up to 8000 psig (551 bar) during relief					6000 psig (413 bar)				300 psig (20.6 bar)			
Outlet Working Pressure ^①	1500 psig (103 bar)					2500 psig (172 bar)				225 psig (15.5 bar)			
Set Pressure	50 to 6000 psig (3.4 to 413 bar)					50 to 1500 psig (3.4 to 103 bar)				10 to 225 psig (0.7 to 15.5 bar)			
Seal Material	Fluoro-carbon FKM	Buna N	Neo-prene	Ethylene pro-pylene	Perfluoro-carbon FFKM	Fluoro-carbon FKM	Buna N	Neo-prene	Ethylene pro-pylene	Fluoro-carbon FKM	Buna N	Neo-prene	Ethylene pro-pylene
Temperature, °F (°C)	Maximum Set Pressure, psig (bar)												
-40 (-40)	6000 (413)	6000 (413)	6000 (413)	6000 (413)	2500 (172)	1500 (103)	1500 (103)	1500 (103)	1500 (103)	225 (15.5)	225 (15.5)	225 (15.5)	225 (15.5)
-30 (-34)													
-10 (-23)													
0 (-17)													
10 (-12)													
25 (-4)	6000 (413)	6000 (413)	6000 (413)	6000 (413)	6000 (413)	1500 (103)	1500 (103)	1500 (103)	1500 (103)	225 (15.5)	225 (15.5)	225 (15.5)	225 (15.5)
30 (-1)													
40 (4)													
50 (10)	6000 (413)	6000 (413)	6000 (413)	6000 (413)	6000 (413)	1500 (103)	1500 (103)	1500 (103)	1500 (103)	225 (15.5)	225 (15.5)	225 (15.5)	225 (15.5)
70 (20)													
150 (65)	5580 (384)	5580 (384)	5580 (384)	5580 (384)	3000 (207)	1500 (103)	1500 (103)	1500 (103)	1500 (103)	225 (15.5)	225 (15.5)	225 (15.5)	225 (15.5)
200 (93)	5160 (355)	5160 (355)	5160 (355)	5160 (355)	1500 (103)								
250 (121)	4910 (338)	4910 (338)	4910 (338)	4910 (338)	—	1500 (103)	1500 (103)	1500 (103)	1500 (103)	225 (15.5)	225 (15.5)	225 (15.5)	225 (15.5)
275 (135)	—	—	4660 (321)	—	—								
300 (148)	—	—	4660 (321)	—	—	—	—	—	—	—	—	—	—

① Outlet pressure should not exceed inlet pressure.

Set Pressure and Resealing Pressure

- Set pressure is the upstream pressure at which the first indication of flow occurs. Set pressure of each valve **after initial relief** is repeatable within
 - ± 3.0 psig (0.20 bar) or ± 5 % (whichever is greater) of the initial set pressure at 60 to 80°F (15 to 26°C)
 - ± 6.0 psig (0.40 bar) or ± 20 % (whichever is greater) of the initial set pressure below 60°F (15°C) and above 80°F (26°C).
- Resealing pressure is the upstream pressure at which there is no indication of flow. Resealing pressure is always lower than set pressure.

Testing

Every R series proportional relief valve is tested for set and resealing performance.

Series	Test Set Pressure psig (bar)	Minimum Resealing Pressure as a Percentage of Set Pressure, %
RL3, RL4	10 to 20 (0.7 to 1.3)	50
	175 to 225 (12.0 to 15.5)	91
R3A, R4	100 to 200 (6.8 to 13.7)	50
	850 to 1000 (58.5 to 68.9)	84

Back Pressure

High-Pressure Valves (R3A and R4 Series)

The effect of system back pressure is minimized by the design of these high-pressure valves.

Low-Pressure Valves (RL3 and RL4 Series)

System back pressure increases the set pressure of the valve. To compensate, multiply the back pressure by 0.8 and subtract the result from the desired set pressure. Use the result to pre-set the valve while back pressure is equal to atmospheric pressure.

Example:

Desired set pressure is 120 psig. System back pressure is 40 psig.

Step 1. Multiply back pressure by 0.8.

$$40 \text{ psig} \times 0.8 = 32 \text{ psig.}$$

Step 2. Subtract result from desired set pressure.

$$120 \text{ psig} - 32 \text{ psig} = 88 \text{ psig.}$$

Step 3. Pre-set proportional relief valve to 88 psig.

Cleaning and Packaging

All Swagelok R series relief valves are cleaned and packaged in accordance with Swagelok *Standard Cleaning and Packaging (SC-10)* (MS-06-62).

Materials of Construction

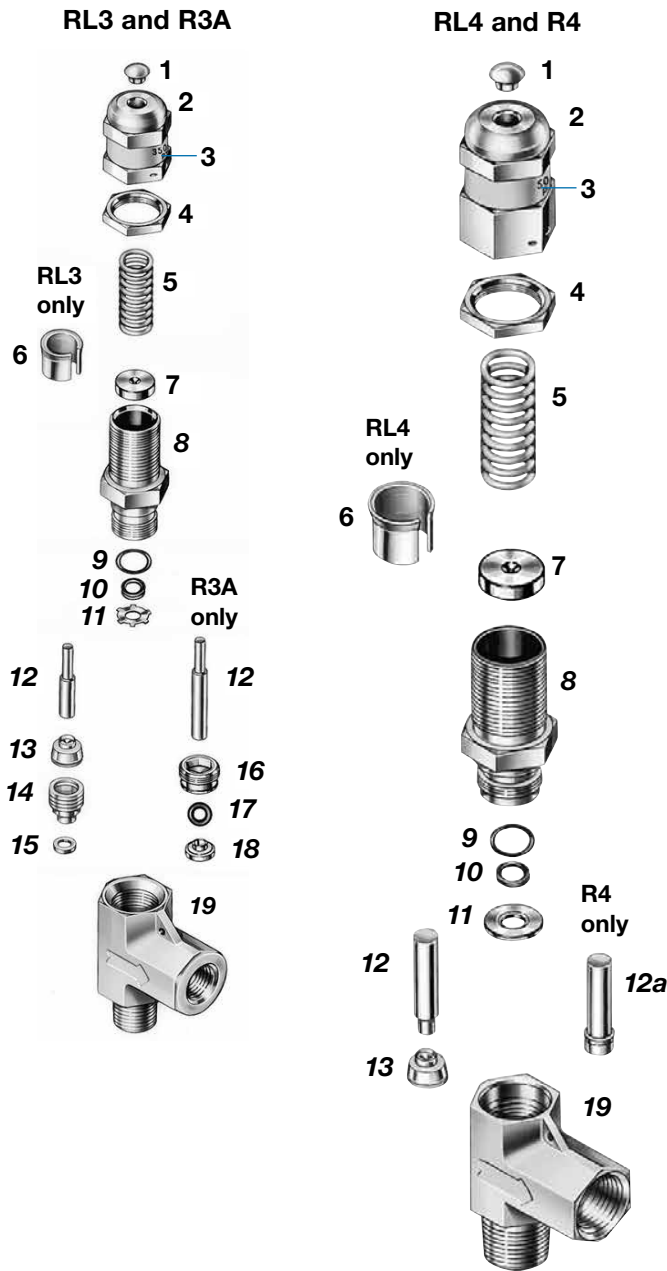

Component	Material Grade/ASTM Specification
1 Plug	302 SS/ASTM 240
2 Cap	316 SS/A479
3 Label	Polyester
4 Lock nut	RL3, R3A—powdered metal 300 series SS/B783; RL4, R4—316 SS/A276
5 Spring	S17700 SS/AMS 5678
6 Sleeve	304 SS/A240
7 Spring support	RL3, R3A—powdered metal 300 series SS/B783; RL4, R4—316 SS/A276
8 Bonnet	316 SS/A479
9 O-ring	Fluorocarbon FKM
10 Quad seal	PTFE-coated fluorocarbon FKM
11 Retainer	RL3, R3A—316 SS/A666; RL4, R4—316 SS/A479
12 Stem	316 SS/A479
12a Bonded stem	Fluorocarbon FKM-bonded ^①
13 Bonded disc	316 SS/A479
14 Seat	316 SS/A479
15 Gasket	PTFE-coated 316 SS/A240
16 Seat retainer	316 SS/A479
17 O-ring	Fluorocarbon FKM
18 Insert	316 SS/A479
19 Body	316 SS/A182
Lubricants	Molybdenum disulfide-based dry film and paste; silicone-based

Wetted components listed in *italics*.

① Material Safety Data Sheet for bonding agents available on request.

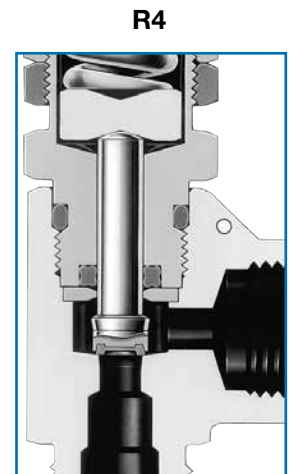
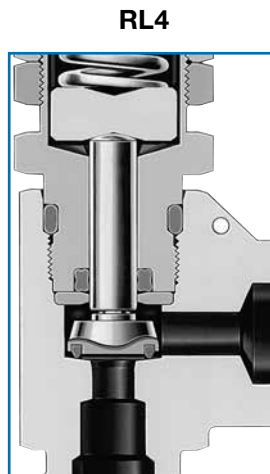
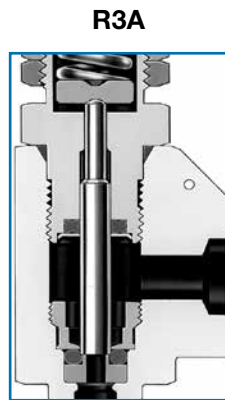
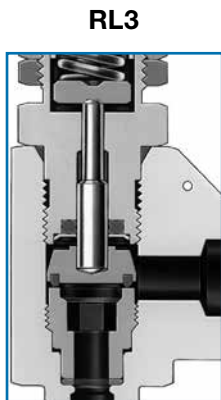

Flow Data at 70°F (20°C)

Air

RL3 and RL4 Series

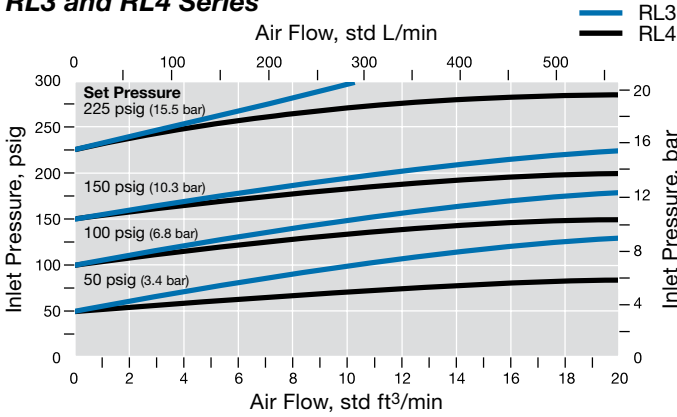

Water

RL3 and RL4 Series

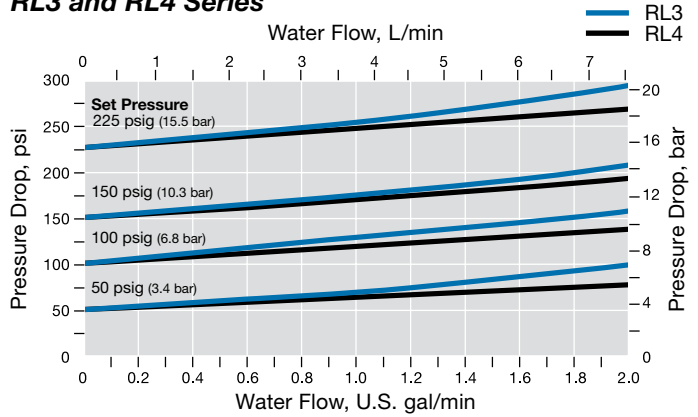

R3A and R4 Series

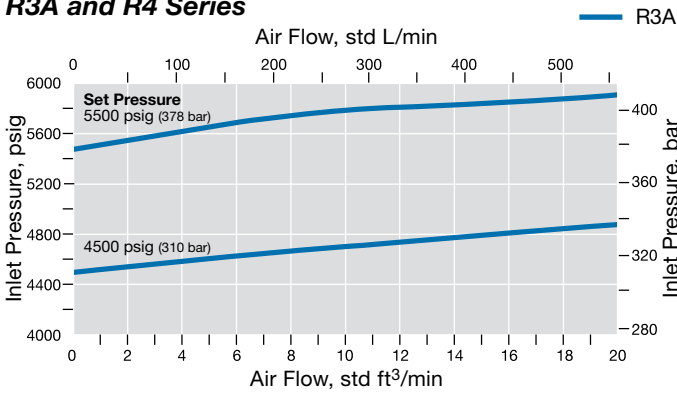

R3A and R4 Series

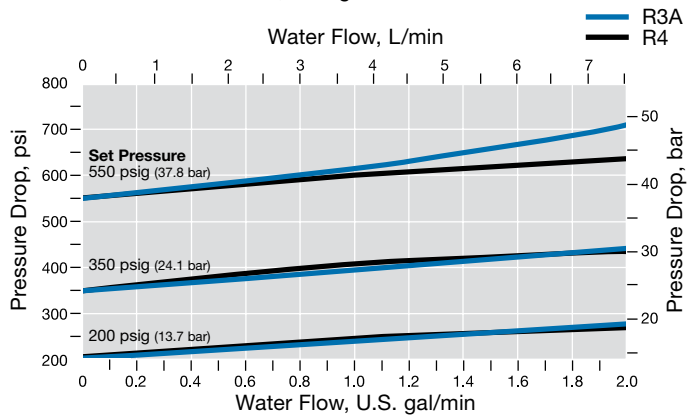
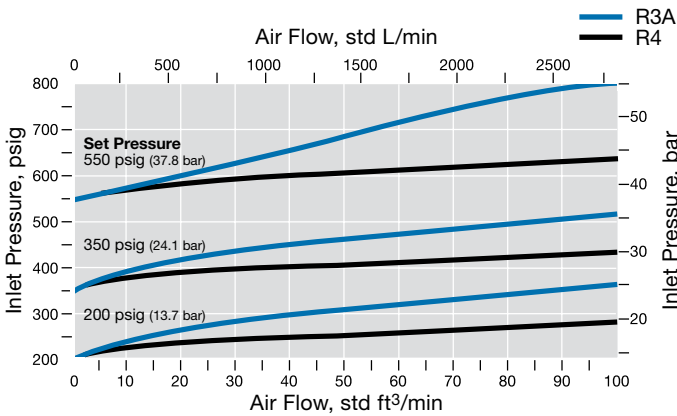
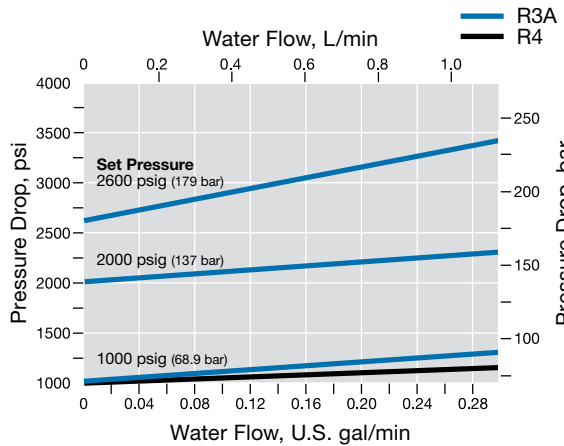
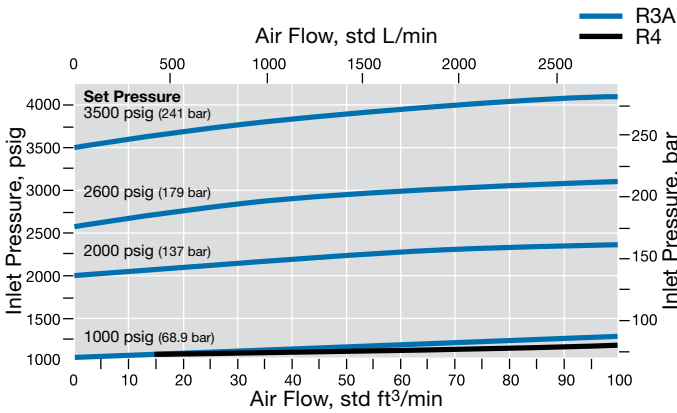
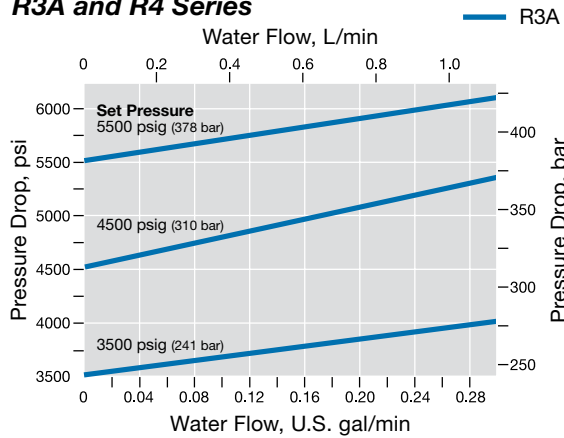

Dimensions

Dimensions are for reference only and are subject to change.

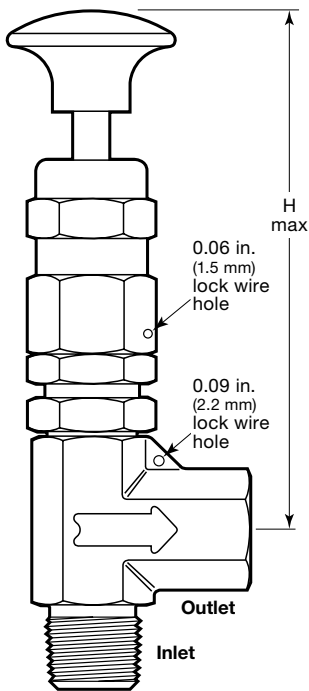
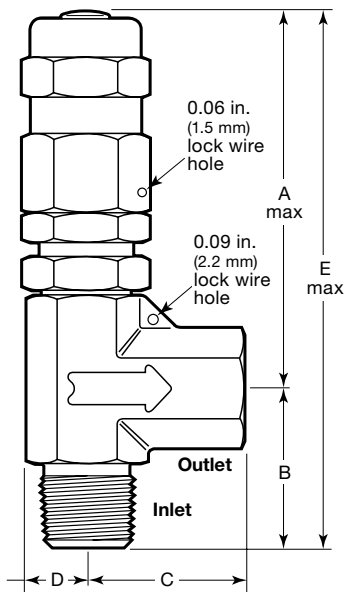

Valve with Manual Override Handle

Low-Pressure Valves (RL3 and RL4 Series)

End Connections		Ordering Number	Dimensions, in. (mm)					
Inlet/Outlet	Size		A	B	C	D	E	H
RL3 series: 0.19 in. (4.8 mm) fully open orifice								
Swagelok tube fittings	1/4 in.	SS-RL3S4	2.70 (68.6)	1.44 (36.6)	1.60 (40.6)	0.43 (10.9)	3.89 (98.8)	4.09 (104)
	6 mm	SS-RL3S6MM						
	8 mm	SS-RL3S8MM						
Male NPT/ Swagelok tube fitting	1/4 in.	SS-RL3M4-S4	1.19 (30.2)	1.60 (40.6)	0.43 (10.9)	3.89 (98.8)	4.09 (104)	
Male NPT/ female NPT	1/4 in.	SS-RL3M4-F4	1.19 (30.2)	1.17 (29.7)				
Male ISO/ female ISO ^①	1/4 in.	SS-RL3M4F4-RT	1.19 (30.2)	1.17 (29.7)				
RL4 series: 0.25 in. (6.4 mm) fully open orifice								
Swagelok tube fittings	1/2 in.	SS-RL4S8	4.09 (104)	1.83 (46.5)		0.50 (12.7)	5.52 (140)	5.37 (136)
	12 mm	SS-RL4S12MM						
Male NPT/ Swagelok tube fitting	1/2 in.	SS-RL4M8S8	1.43 (36.3)	1.83 (46.5)	0.50 (12.7)	5.52 (140)	5.37 (136)	
Male NPT/ female NPT	1/2 in.	SS-RL4M8F8	1.43 (36.3)	1.43 (36.3)				
			5.52 (140)					

High-Pressure Valves (R3A and R4 Series)

End Connections		Ordering Number	Dimensions, in. (mm)					
Inlet/Outlet	Size		A	B	C	D	E	H
R3A series: 0.14 in. (3.6 mm) fully open orifice								
Swagelok tube fittings	1/4 in.	SS-4R3A	2.70 (68.6)	1.44 (36.6)	1.60 (40.6)	0.43 (10.9)	3.89 (98.8)	4.09 (104)
	6 mm	SS-6R3A-MM						
	8 mm	SS-8R3A-MM						
Male NPT/ Swagelok tube fitting	1/4 in.	SS-4R3A1	1.19 (30.2)	1.60 (40.6)	0.43 (10.9)	3.89 (98.8)	4.09 (104)	
Male NPT/ female NPT	1/4 in.	SS-4R3A5	1.19 (30.2)	1.17 (29.7)				
Male ISO/ female ISO ^①	1/4 in.	SS-4R3A5-RT	1.19 (30.2)	1.17 (29.7)				
R4 series: 0.25 in. (6.4 mm) fully open orifice								
Swagelok tube fittings	1/2 in.	SS-R4S8	4.09 (104)	1.83 (46.5)		0.50 (12.7)	5.52 (140)	5.37 (136)
	12 mm	SS-R4S12MM						
Male NPT/ Swagelok tube fitting	1/2 in.	SS-R4M8S8	1.43 (36.3)	1.83 (46.5)	0.50 (12.7)	5.52 (140)	5.37 (136)	
Male NPT/ female NPT	1/2 in.	SS-R4M8F8	1.43 (36.3)	1.43 (36.3)				
			5.52 (140)					

Dimensions shown with Swagelok tube fitting nuts finger-tight.

^① See specifications ISO 7/1, BS EN 10226-1, DIN-2999, and JIS B0203.

Ordering Information

Low-Pressure Valves (RL3 and RL4 Series)

Valve contains spring; set pressure must be adjusted. Select a valve ordering number.

Factory-Set Valves

RL3 and RL4 series valves are available with springs factory-set to a specified set pressure. Valves are set, tested, locked, and tagged with the set pressure; certificates of test are included.

To order, add **-SET** to the valve ordering number and specify the desired set pressure.

Example: SS-RL3S4-**SET**

Replacement Spring Kits

Spring kits include spring and installation instructions. Select a spring kit ordering number.

Series	Spring Kit Ordering Number	Set Pressure Range psig (bar)
RL3	177-13K-RL3	10 to 225 (0.7 to 15.5)
RL4	177-13K-RL4	

High-Pressure Valves (R3A and R4 Series)

Valve does not contain spring. Select a valve ordering number and a spring kit ordering number.

Spring Kits

Spring kits include spring, label, 302 SS lock wire with seal, spring support, and installation instructions.

Select a spring kit basic ordering number and add the spring designator for the desired set pressure range.

Examples: **177-R3A-K1-F**
177-13K-R4-C

Set Pressure Range psig (bar)	Spring Designator	Spring Color
R3A series spring kit: basic ordering number 177-R3A-K1-		
50 to 350 (3.4 to 24.1)	A	Blue
350 to 750 (24.1 to 51.7)	B	Yellow
750 to 1500 (51.7 to 103)	C	Purple
1500 to 2250 (103 to 155)	D	Orange
2250 to 3000 (155 to 206)	E	Brown
3000 to 4000 (206 to 275)	F	White
4000 to 5000 (275 to 344)	G	Red
5000 to 6000 (344 to 413)	H	Green
R4 series spring kit: basic ordering number 177-13K-R4-		
50 to 350 (3.4 to 24.1)	A	Blue
350 to 750 (24.1 to 51.7)	B	Yellow
750 to 1500 (51.7 to 103)	C	Purple

Factory-Set Valves

R3A and R4 series valves are available with springs factory-set to a specified set pressure. Valves are set, tested, locked, and tagged with the set pressure; certificates of test are included.

To order, add **-SET** and a spring designator whose range includes the desired set pressure to the valve ordering number; specify the desired set pressure.

Example: SS-4R3A-**SETB**

Options and Accessories

Seal Materials

Fluorocarbon FKM is the standard seal material. Buna N, ethylene propylene, and neoprene and perfluorocarbon FFKM are available.

Quad seal elastomers are PTFE-coated.

To order a *valve* with an optional seal material, add a valve seal material designator to the valve ordering number.

Examples: SS-4R3A-**BU**
SS-RL3S4-**BU**

To order a *replacement seal kit*, insert a seal kit material designator as a prefix (R3A series) or suffix (all others) to the seal kit basic ordering number.

Examples: **BU**-R3A-K2
SS-3K-RL3-**BN**

Seal Material	Designator	
	Valves	Seal Kits
Buna N	-BU	BN ^①
Ethylene propylene	-EP	EP
Neoprene	-NE	NE
Perfluorocarbon FFKM ^②	-KZ	KZ
Fluorocarbon FKM	—	VI

^① Use **BU** for R3A series seal kits.

^② Only available for R3A series.

RL3 Series	R3A Series	RL4 Series	R4 Series
Seal kit basic ordering number			
SS-3K-RL3-	-R3A-K2	SS-3K-RL4-	SS-3K-R4-
Seal kit contents			
O-ring, quad seal, bonded disc, retainer, instructions	O-rings (2), quad seal, retainer, instructions	O-ring, quad seal, bonded disc, retainer, instructions	O-ring, quad seal, bonded stem, instructions

Special Cleaning and Packaging (SC-11)

To order R series relief valves processed in accordance with Swagelok *Special Cleaning and Packaging (SC-11)* (MS-06-63) to ensure compliance with product cleanliness requirements stated in ASTM G93 Level C, add **-SC11** to the valve ordering number.

Example: SS-RL3S4-**SC11**

Oxygen Service Hazards

For more information about hazards and risks of oxygen-enriched systems, see the Swagelok *Oxygen System Safety* technical report (MS-06-13).

Options and Accessories

Manual Override Handles

A manual override handle opens the valve without changing the set pressure.

For use with:

- RL3 and RL4 series—standard spring
- R3A series—A, B, and C springs only
- R4 series—A spring only.

Handle diameter is 1.50 in. (38.1 mm). Maximum overall height of valve with handle in closed position:

- 5.16 in. (131 mm) for R3A and RL3 series
- 6.78 in. (172 mm) for R4 and RL4 series.

To order, add **-MO** to the valve ordering number.

Example: SS-RL3S4-**MO**

Manual Override Handle Kits

Kits contain handle, pull rod, spring support, and instructions. To order, select the desired kit ordering number.

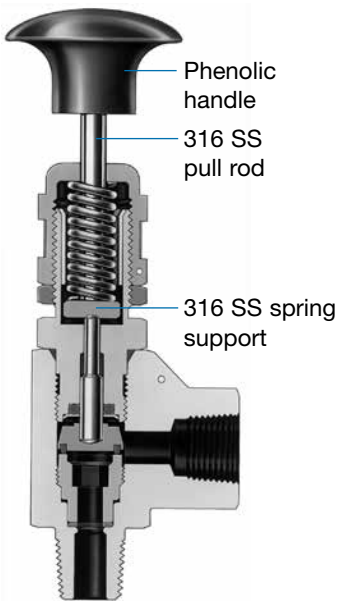

Proportional Safety Relief Valves

Swagelok PRV series proportional safety relief valves are certified to PED 2014/68/EU. For more information, see the Swagelok *Proportional Safety Relief Valves* catalog, MS-02-432.



Series	Manual Override Kit Ordering Number
RL3, R3A	SS-R3A-K5
RL4, R4	SS-R4-K5

Caution: Do not mix or interchange parts with those of other manufacturers.

About this document

Thank you for downloading this electronic catalog, which is part of General Product catalog Swagelok published in print. This type of electronic catalog is updated as new information arises or revisions, which may be more current than the printed version.

Swagelok Company is a major developer and provider of fluid system solutions, including products, integration solutions and services for industry research, instrumentation, pharmaceutical, oil and gas, power, petrochemical, alternative fuels, and semiconductor. Our manufacturing facilities, research, service and distribution facilities support a global network of more than 200 authorized sales and service centers in 57 countries.

Visit www.swagelok.com to locate your Swagelok representative and obtain any information on features, technical information and product references, or to learn about the variety of services available only through authorized sales centers and service Swagelok.

Safe Product Selection

When selecting a product, the total system design must be considered to ensure safe, trouble-free performance. Function, material compatibility, adequate ratings, proper installation, operation, and maintenance are the responsibilities of the system designer and user.

Warranty Information

Swagelok products are backed by The Swagelok Limited Lifetime Warranty. For a copy, visit your Swagelok Web site or contact your authorized Swagelok representative.

Swagelok, Ferrule-Pak, Goop, Hinging-Colleting, IGC, Kenmac, Micro-Fit, Nupro, Snoop, Sno-Trik, SWAK, VCO, VCR, Ultra-Torr, Whitey—TM Swagelok Company
Aflas—TM Asahi Glass Co. Ltd.
AL-6XN—TM Allegheny Ludlum Corporation
AutoCAD—TM Autodesk, Inc.
CSA—TM Canadian Standards Association
DeviceNet—TM ODVA
Kalrez, Krytox—TM DuPont
Elgiloy—TM Elgiloy Specialty Metals
FM—TM FM Global
Grafoil—TM GrafTech International Holdings, Inc.
MAC—TM MAC Valves Inc.
Microsoft, Windows—TM Microsoft Corp.
NACE—TM NACE International
Nitronic—TM AK Steel Corporation
picofast—TM HansTurck KG
Pillar—TM Nippon Pillar Packing Company, Ltd.
Rapid Tap—TM Relton Corporation
15-7 PH, 17-7 PH—TM AK Steel Corp.
Sandvik—TM SandvikAB
Silconert—TM Silcotek Corporation
Simriz—TM Freudenberg-NOK
SolidWorks—TM SolidWorks Corporation
© 2017 Swagelok Company